

← SEE NEXT PAGE

the customer.  
the Distributor. The Distributor will pay for the expense of returning the product to  
warranty period. The customer will pay for the expense of delivering the product to  
product including any defective part must be sent to the Distributor within the  
will be repaired or replaced by the Distributor without charge for parts or labor. The  
reasonable judgment of the Distributor to be defective in material or workmanship  
Service Center. Any part of the product supplied by the Distributor and found in the  
Ask your local Distributor for the warranty period in your region by calling their  
authorized dealer.

Distributors ONLY warrant Stallion products purchased from an  
Distributors ONLY warrant Stallion products purchased from an  
www.seadooseascooter.com for distributor/Service Centre details.  
local distributor for warranty arrangements in your territory. Please visit  
you're not located in the United States or Canada, please contact your  
Warranty for 6 months from the date of purchase for new products. If  
Distributors in the United States and Canada provide a standard Limited

**ALWAYS ACTIVATE YOUR WARRANTY IMMEDIATELY ON**  
<http://www.seadooseascooter.com/warranty.html>

**Distributors ONLY warrant products with an active**  
**Warranty Registration**

## WARRANTY & CUSTOMER SERVICE INFORMATION

[www.seadooseascooter.com](http://www.seadooseascooter.com)



## User Manual English Version

SDP95004



SEA-DOO® SEASCOOTER™ GTI

Model no. ZS05 / SD5540

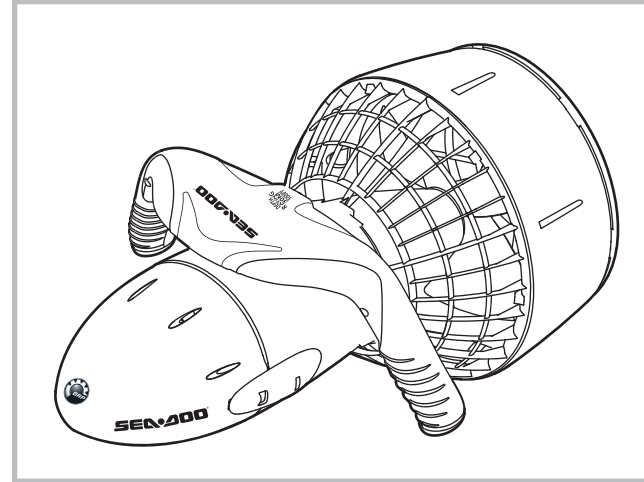

### CAUTION

#### ELECTRICALLY OPERATED PRODUCT

Not recommended for children under 16 years of age. As with all electrical products, precautions should be observed during handling and used to reduce the risk of electric shock.

## Contents

Introduction	1
Parts diagram	2
WARNINGS	3
Getting started	6
Battery use	9
Care & Maintenance	18
Trouble Shooting	20
Technical Specifications	25

## Instruction

Thank you for having chosen the SEA-DOO® SEASCOOTER™ GTI - with the SEASCOOTER™ swimming, snorkeling and diving is effortless and fun.

Years of design and engineering have resulted in a personal water propeller that gives you power - up to 2.5 mph/4km/h for up to 120 minutes of use at a depth of up to 30m/100ft - but at the same time is compact and light.

There are many features incorporated in this sophisticated design, please take time to study the manual to learn about them all to get the most out of your SEASCOOTER™.

1

## Parts Diagram

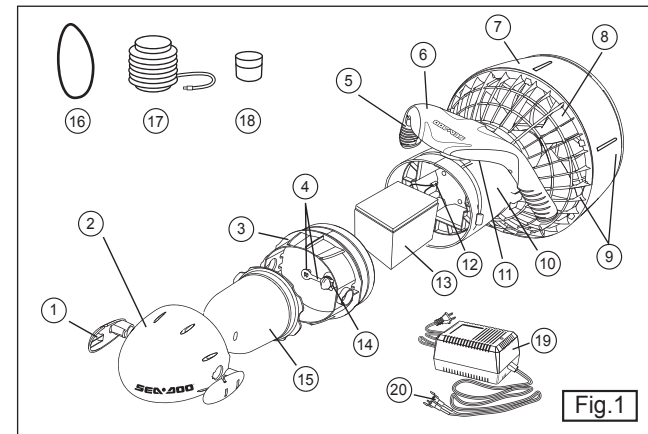

- |                      |                            |
|----------------------|----------------------------|
| ① Latch              | ⑫ Battery Leads            |
| ② Nose Cone          | ⑬ Battery                  |
| ③ Inner Nose Cone    | ⑭ Vent Hole                |
| ④ Vent Plug          | ⑮ Buoyancy Control Chamber |
| ⑤ Trigger            | ⑯ Charger                  |
| ⑥ Handle             | ⑰ Pump                     |
| ⑦ Nozzle             | ⑱ Lubricant                |
| ⑧ Propeller          | ⑲ Charger                  |
| ⑨ Protective Grilles | ⑳ Charger Jack             |
| ⑩ Battery Housing    |                            |
| ⑪ Master Switch      |                            |

2

## WARNINGS

- Read the user's manual carefully.
- Never remove the grilles except for maintenance.
- Never stick body parts, clothing or other objects in the vicinity of the Propeller. Do not wear loose or flowing clothing or equipment that could be drawn into the Propeller.
- Particular care should be exercised when using the SEASCOOTER™ near anybody with long hair. Users with long hair should tie it up or wear a swimming cap when using the SEASCOOTER™.
- Always inspect the swimming area to ensure it is free of hazards or obstacles such as boats and swimmers before using the SEASCOOTER™.
- Always charge battery to its fullest before using the SEASCOOTER™. After charging is complete the battery will continue to off gas. Wait at least 30 minutes after charging before removing the battery from the charger or placing the battery into the battery housing. Failure to do so could result in an explosion.
- Ensure sufficient battery charge remains for return to shore or surface.
- The Seascooter™ is not a personal floatation device - always wear a Approved Personal Flotation Device / Approved Life-Preserver when using the Seascooter™ for snorkeling.
- Be aware of appropriate water levels, tidal changes, dangerous currents, weather changes and strong offshore winds. Always scout unfamiliar water.
- Do not use alcohol or mind-altering drugs prior to using this product.
- ALWAYS keep the SEA-DOO® SEASCOOTER™ GTI out of direct sunlight when not in use. HEAT KILLS BATTERIES.
- When using the SEA-DOO® SEASCOOTER™ GTI for SCUBA, ascents and descents should be made in accordance with recognized diving practices.
- The SEA-DOO® SEASCOOTER™ GTI should only be used for SCUBA by qualified divers.
- Always follow this age recommendation: a child under 16 years old should never operate this SEA-DOO® SEASCOOTER™ GTI .
- Never open the Cover of the SEA-DOO® SEASCOOTER™ GTI in the water.
- When not in use, always turn the Master Switch to the off position.
- Do not use the SEASCOOTER™ below the recommended maximum depth of 30m/100ft.
- ALWAYS remove the battery from the unit when not in use.
- DO NOT store the battery in the unit

## Getting Started

When you buy the SEA-DOO® SEASCOOTER™ GTI the battery is disconnected and needs to be charged. Follow the safety cautions on pages 9 to 12 and charging instructions on pages 13 to 16.

### **Using the SEASCOOTER™ for swimming and snorkeling.**

When swimming or snorkelling the SEA-DOO® SEASCOOTER™ GTI should be kept positively buoyant - this is done by simply making sure the Buoyancy Chamber is empty and fitted inside the Nose Cone.

To use the SEASCOOTER™ for swimming or snorkeling follow these instructions.

1. Charge the battery and install just before use.
2. Make sure that Vent Plug is closed.
3. Place the SEA-DOO® SEASCOOTER™ GTI into the water so the Handle, Outer Nose Cone and Nozzle fill with water.
4. When ready to set off, switch the Master Switch to the On position shown in figure 2.
5. Pull and hold both Triggers to start the Propeller.  
(There is a short delay before the Propeller begins to rotate).
6. To stop the Propeller, simply release the Trigger.
7. Always turn the Master Switch off when out of the water.

5

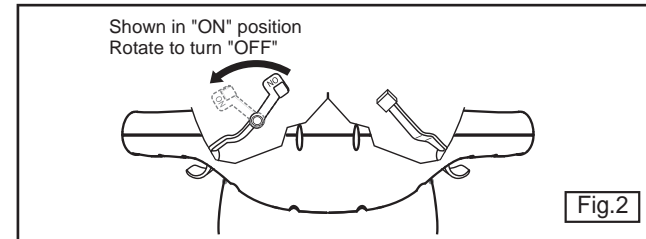

8. Proper posture when using the SEA-DOO® SEASCOOTER™ GTI is important to achieve the maximum speed - see figure 3 for the correct position of the SEA-DOO® SEASCOOTER™ GTI when using it.

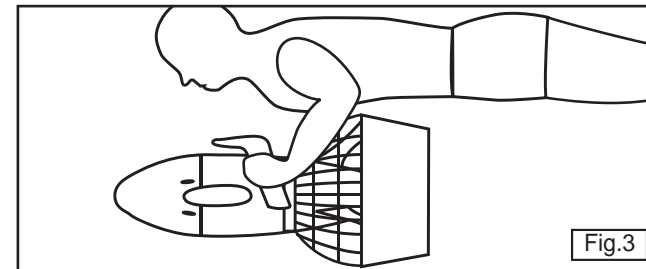

### **CAUTION**

Do not dive deeper than you would normally when snorkeling, to ensure you can get back to the surface safely.

6

**Using the SEA-DOO® SEASCOOTER™ GTI for diving - adjusting the buoyancy.**

Your SEASCOOTER™ can be used for diving up to 30m/100ft but will need to be adjusted for neutral buoyancy. The SEASCOOTER™ must never be adjusted for negative buoyancy to avoid it sinking if accidentally released.

**To adjust for neutral buoyancy follow these instructions**

1. Make sure the SEA-DOO® SEASCOOTER™ GTI is in the Off position.
2. Remove the SEASCOOTER™ from the water, give a half turn to the Latches, remove them (see figure 4) and remove the Buoyancy Control Chamber.

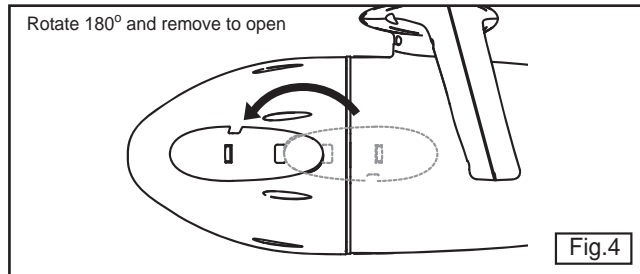

3. Open the Buoyancy Chamber and add a small amount of rocks or a lead weight (see figure 5).
4. Replace the Buoyancy Chamber and the Nose Cone and latches and place the SEASCOOTER™ in the water. If the SEASCOOTER™ is neutrally buoyant it will just float in the water.

7

5. If the SEASCOOTER™ sinks, remove the weight until it is neutrally buoyant.

If the SEASCOOTER™ is still positively buoyant repeat step 3, until it is neutrally buoyant.

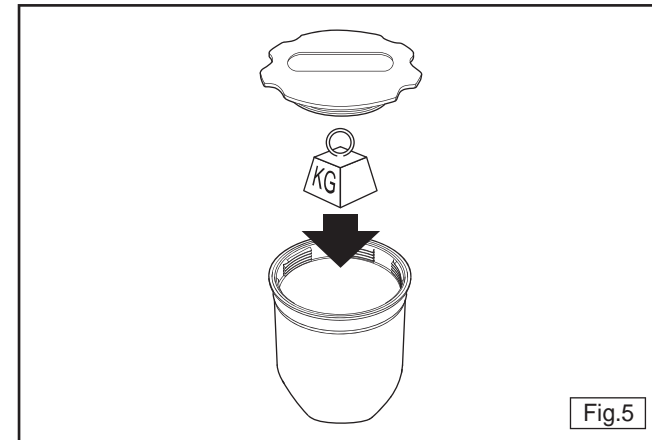

**CAUTION**

If the SEASCOOTER™ is later used for swimming or snorkeling be sure to remove the weight from the Buoyancy Chamber so the SEA-DOO® SEASCOOTER™ GTI has positive buoyancy.

8

## Battery Use

**WARNING**  
BATTERY SAFETY

RE-CHARGE THE BATTERY  
AT LEAST  
**3 MONTHS**

- Must remove and store the battery separately from the unit when not in use!
- Must re-charge the battery after use WITHIN 24 HOURS.
- Must re-charge the battery at least **EVERY THREE MONTHS** when not in use.

*User Manual must be read and understood before use.*

**No warranty for the battery, Please read and follow the Battery Safety Instruction**

**Incorrect battery maintenance may reduce the battery life and influence its function.**

[www.seadooseascooter.com](http://www.seadooseascooter.com)

9

## Battery Use

### CAUTION

- Your SEA-DOO® SEASCOOTER™ GTI is supplied with a battery that needs to be treated carefully as it will release potentially explosive gases during its normal cycle of use (off gassing). Please read the entire manual thoroughly and follow all instructions. Failure to do so can result in an explosion occurring.
- Always remove the battery from your SEA-DOO® SEASCOOTER™ GTI when it is not in use and store separately in a well ventilated area where it is out of the reach of children and away from heat and ignition sources.
- Do not install the battery in your SEA-DOO® SEASCOOTER™ GTI until immediately prior to using it.
- Before disconnecting/connecting any cables, open the nose cone and allow two minutes for any explosive gases to dissipate.
- Do not use/store/charge the battery in temperatures above 40°C (104°F) as excessive off gassing may occur. Keep the battery and SEA-DOO® SEASCOOTER™ GTI in the shade when not in use.
- Always ensure the unit is dried thoroughly before opening the Nose Cone.
- Only use the charger supplied with the SEA-DOO® SEASCOOTER™ GTI.

10

## Battery Use

### CAUTION

- The battery supplied with your SEA-DOO® SEASCOOTER™ GTI releases a potentially explosive gas during charging. Charging should only take place in a well ventilated area, away from children and naked flames or other ignition sources (cigarettes, sparks). Never charge the battery whilst still in the SEA-DOO® SEASCOOTER™ GTI.
- Charge the battery as soon as possible after use within 24 hours.
- Always charge the battery to the fullest before using the SEA-DOO® SEASCOOTER™ GTI.
- Always remove the battery from the battery housing before charging.
- Always connect charger jack to the battery first and then plug charger into the mains.
- After charging, disconnect from the mains first and then disconnect the battery from the charger.
- After charging is complete the battery will continue to off gas. Wait at least 30 minutes after charging before removing the battery from the charger or placing the battery into the battery housing. Failure to do so could result in an explosion.
- Remove battery from charge once fully charged.

11

## Battery Use

### CAUTION

- Never charge the battery in sealed container.
- Never charge the battery near water.
- Never short circuit the battery or battery connectors.
- Always ensure the charger is dry before use.
- The charger gets quite warm in use - this is normal.
- If in doubt of the state of the battery, recharge it until the indicator on the battery charger indicates a full charge.
- If the battery is not to be used for an extended period, store it in a well ventilated area away from children, heat and ignition sources and recharge it every three months to maintain charge and avoid excess of gassing. DO NOT store the battery inside the SEA-DOO® SEASCOOTER™ GTI.
- If the battery appears damaged or will not charge fully, the battery must be replaced. If battery life is noticeably reduced, the battery should be replaced.

12

## Battery Use

### **Charging the battery**

For battery charging follow these instructions.

1. Always ensure that the Master Switch is Off - see figure 2.
2. Always ensure that the SEA-DOO® SEASCOOTER™ GTI is out of the water, dry and placed in a dry area.
3. Give a half turn to the Latches and remove them from the Nose Cone as shown in figure 4.
4. Remove the Outer Nose Cone and Buoyancy Control Chamber.
5. Open the Vent by unscrewing the Vent Plug.
6. Remove the Inner Nose Cone. To do this, first feed the silicone ring (provided with this manual) through the latch holes in the Inner Nose Cone and hook over the hooks on the Battery Housing (see figure 6). Then screw the Pump Nozzle onto the Vent Hole and pump air into the Battery Chamber until the Inner Nose Cone pops off and then remove the silicone ring.
7. Allow two minutes for any gasses to dissipate.
8. Disconnect the battery cable from the housing cable (if not already disconnected - the cable will be disconnected when you buy your SEASCOOTER™) by pressing the locking feature, as shown in figure 7.

13

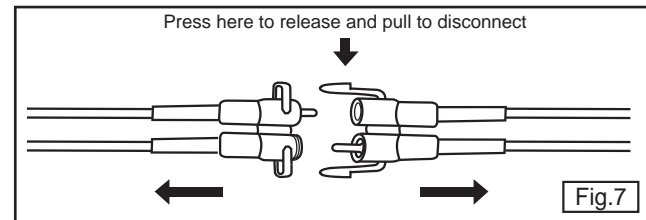
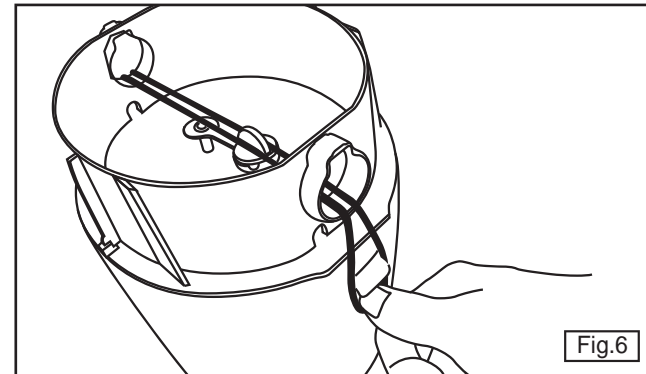

9. Remove the battery and place on a level surface.
10. Connect the battery cable to the charger cable.
11. Plug charger into mains, and turn on the supply.
12. Charging will take 6 to 8 hours for a fully discharged battery. Flashing light indicates battery is fully charged.
13. Unplug the adapter from the mains.
14. Allow battery to stand for 30 minutes before using it.
15. Unplug the battery cable from the Charger cable.
16. When ready for use, install the battery and reconnect to the housing cable.

14

17. Make sure the seals and sealing surfaces are clean and lubricated before replacing the Inner Nose Cone. See fig.8

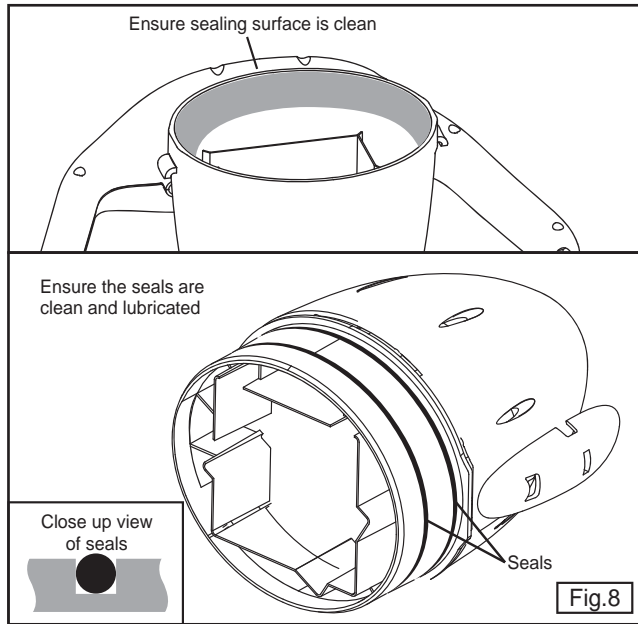

18. Replace the Inner Nose Cone making sure the key is aligned correctly. See fig. 9.

19. Ensure the Vent O Ring is fitted correctly. See fig. 10.

20. Screw in the Vent Plug to seal the vent.

15

21. Replace the Buoyancy Control Chamber.

22. Replace the Outer Nose Cone making sure the key is aligned correctly and insert the Latches and lock the Nose Cone by giving them a half turn. See fig.11.

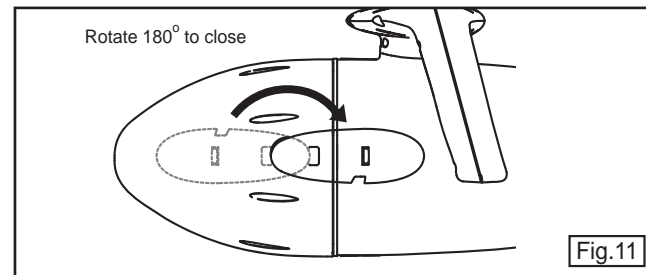
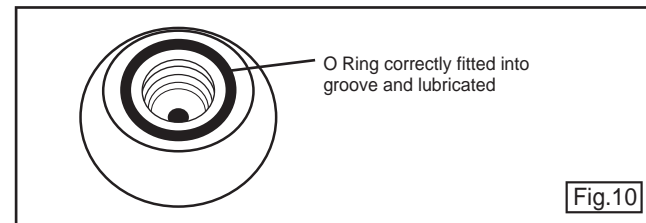
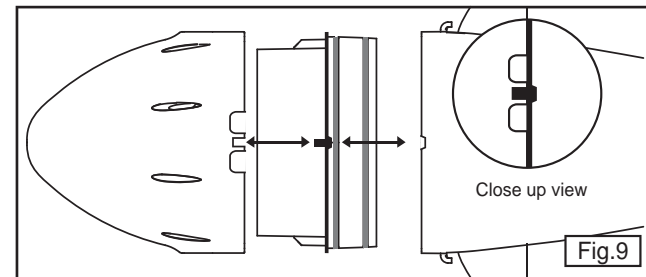

16

## Care And Maintenance

### **To replace a flat battery with a fully charged battery.**

1. Follow the steps 1 to 7 on page 12, to open the SEASCOOTER™.
2. Unplug the battery at the socket by pressing the locking feature shown in figure 7.
3. Remove the flat battery.
4. Install and connect the charged battery in the correct position - the leads of the battery must be oriented as shown on the sticker on the battery, see figure 12.

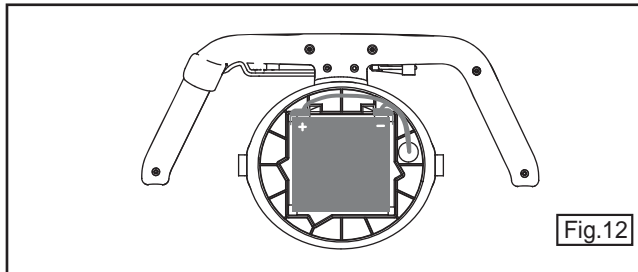

5. Follow steps 17 to 22 on page 14 and 15, to close the SEASCOOTER™.

### **Buying batteries**

Additional standard or extended batteries can be purchased separately. Contact your local customer service centre/distributor to purchase them.

17

### **Battery Care**

- Please read and understand important Battery Use safety information on pages 9 to 12.
- The battery supplied with your SEASCOOTER™ should last about 200 cycles or two years before it should be replaced. Please contact your local customer service centre/distributor. Using a battery in excess of these recommendations can result in excessive of gassing of explosive gas.
- ALWAYS remove the battery from the SEASCOOTER™ immediately after use.

### **DO NOT STORE BATTERY IN SEASCOOTER™**

### **Care after using the SEASCOOTER™**

- Always rinse the SEASCOOTER™ in fresh water and allow it to dry before storage.
- Whenever possible rinse the SEASCOOTER™ in fresh water immediately after use.
- To clean the SEASCOOTER™ do not use detergents, only use a damp cloth to wipe the unit clean.
- The Battery Housing interior should be kept dry at all times.
- If the Battery Housing interior ever gets wet, see page 24, Accidental Flooding for procedure.

18

- When storing the SEASCOOTER™ for extended periods of time, open the Vent Plug in the Inner Nose Cone.
- DO NOT store battery in SEASCOOTER™.
- ALWAYS store your SEASCOOTER™ vertically when not in use to prevent deformation of the Propeller Nozzle.

## Trouble Shooting

### ***Unit does not function***

If the motor does not start when both triggers are pressed, make sure

1. The battery is properly connected
2. The battery is fully charged  
(see page 13, charging the battery)
3. The master switch is in the "On" position  
(see fig 2, page 6)
4. There is no water in the battery compartment  
(see page 24, accidental flooding)

### ***Blocked Propeller***

If the Propeller becomes blocked first try and remove the obstruction by removing the front grille. If this is not possible the back grille and Propeller can be removed.

Under normal use the grilles must not be removed.

Removing the front grille to remove an obstruction.

1. Remove the SEASCOOTER™ from the water.
2. Make sure the master switch is in the Off position.
3. Insert a screw driver as shown in figure 13 (page 21) to remove the two grille pins.
4. Unclip grille as shown in figure 14 (page 21) .
5. Remove obstruction.
6. Reassemble grille and insert clips.

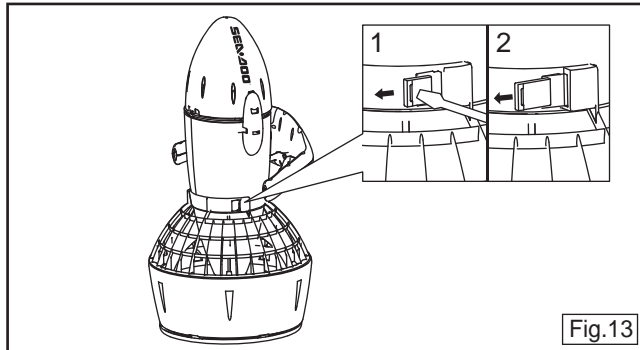

Fig.13

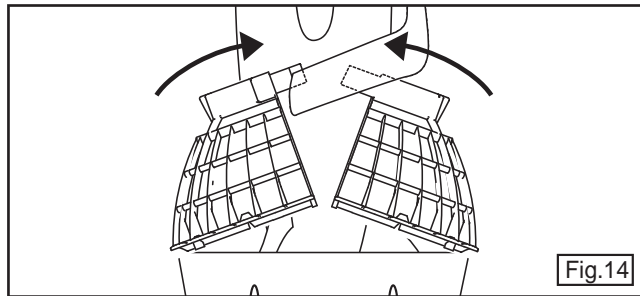

Fig.14

**Removing rear grille and Propeller to remove obstruction**

1. Remove the SEASCOOTER™ from the water.
2. Make sure the master switch is off.
3. Remove the battery - see page 13, step 1-9.
4. Unscrew the six rear grille screws as shown in figure 15.

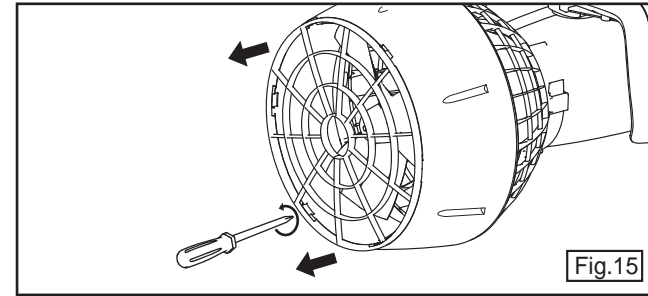

Fig.15

5. Whilst holding the Propeller, use an M6 socket to remove the nut from the Propeller shaft (See figure 16).

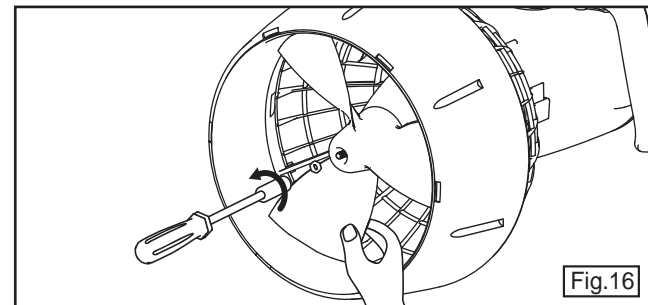
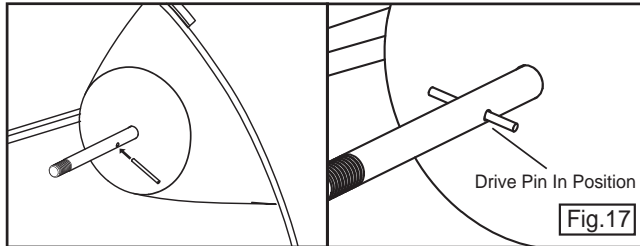

Fig.16

6. Slide the Propeller off the shaft, taking care not to lose the drive pin or washers.
7. Remove the blockage from the Propeller.
8. Replace the drive pin (if removed), see figure 17 (page 23), and Propeller. Turn the Propeller slowly until you locate the pin and push the Propeller fully on.



9. Replace the washer(s) and nut and tighten with the socket whilst holding the Propeller making sure it is securely fastened (See figure 18).

10. Replace the grille.

11. Replace the battery.

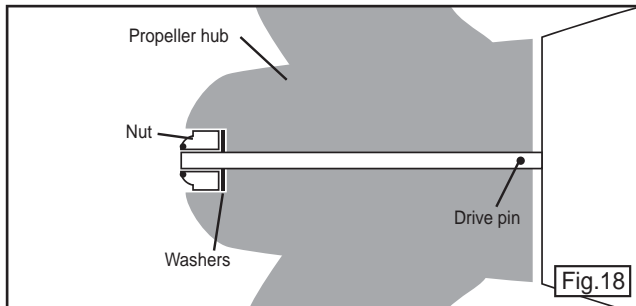

### **Sand or Grit on Seals**

Sand or grit is the enemy of seals. Correct maintenance and care is essential. To remove sand or grit from the seals, rinse the seals in fresh water and apply fresh lubricant. If there is sand inside the Battery Housing, gently brush the sand from the unit taking care not to scratch the sealing surfaces.

### **SEASCOOTER™ cuts out**

To protect the electronic circuit of your SEASCOOTER™ from damage a safety mechanism has been built in that cuts the power if a wall or rock or other immovable object is hit. If this occurs simply wait for a short period to allow the SEASCOOTER™ to reset itself and resume use.

### **Accidental Flooding**

Be sure to keep the seals sand and grit free to ensure they keep water out and to close the vent plug after accessing the battery chamber. However, should the seals not be clean or the vent plug left open and water enter the battery chamber, your Seascooter will not be damaged as it is designed for protection against accidental flooding. If water enters the battery chamber the Seascooter will automatically stop functioning. If this occurs

1. Remove the SEASCOOTER™ from the water if it is safe to do so. Always observe safe diving practice.
2. Remove nose cone and tip out excess water.
3. Wait two minutes for any gases to dissipate, then remove the battery.
4. If salt water has entered, rinse battery and battery housing with fresh water.
5. Dry housing and battery thoroughly.

## Technical Specifications

Unit Dimensions	24 x 15.2 x 12.3" (612 x 385 x 312 mm)
Unit Weight	18 lbs (8.2 kg) (with rechargeable battery)
Battery Type	1 x rechargeable battery
Battery Life	Approximately 2 hours
Depth rating	30m/100ft
Speed	Up to 2.5 mph (4 km/h)

**For more information on  
Sea-Doo® Seascooter™ Products**  
(Warranty, Customer Care / Maintenance,  
Parts & Battery Purchase)

PLEASE VISIT

[www.seadooseascooter.com](http://www.seadooseascooter.com)

Distributed by **Stallion (asia) LTD.**  
Block F, 6/F, Wah Hing Industrial Mansions  
36 Tai Yau Street, San Po Kong, Kowloon, Hong Kong

**Products covered by the following patents:**  
USA, Canada, EU, Australia, Japan, Hong Kong, China & Turkey  
US D471,506S / US D518,768S / D527,702S / US D506,176S / US D507,776S  
D512,678S / D519,911S / 6848385 B2 / US 7000559 B2 / US 7093554 B1 / 11/102,302  
0500577.8 / 0500578.0 / 0500579.2 / HK1072691 / ZL200530005661.5  
ZL200430079550.4 / ZL200430057359.X / ZL200530005662.X / ZL200530005663.4  
ZL200320103738.8 / ZL200520008894.5 / 1194933 / 1254107 / 1225250  
000330311-0001 / 000183900-0001 / 000183900-0002 / 000330279-0001  
000330295-0001 / 03020902.7 / 302949 / 302564 / 302563 / 302950  
302948 / 2005100230 / 200503474 / 29/268,724 / 11/595,675 / 000816376-0001

Toll Free: 1-877-2650996  
service@stallionsport.com  
[www.stallionsport.com](http://www.stallionsport.com)



SEA-DOO® and the BRP logo are trademarks  
of Bombardier Recreational Products Inc. or its affiliates,  
used under licence to Stallion (asia) Ltd.  
For more information on SEA-DOO® products visit [www.sea-doo.com](http://www.sea-doo.com)

**Stallion**  
Product

Patented Print in China

This warranty does not cover any product that has been subject to misuse or negligence or accident, or that has been operated in any way contrary to the operating instructions as specified in the User Manual. This warranty does not apply to any damage to the product that is the result of improper maintenance or to any product that has been altered or modified so as to change its intended use. This warranty does not extend to repairs made necessary by normal wear or by the use of parts or accessories which are either incompatible with the product or adversely affects its operation, performance or durability.

In addition, this warranty does not cover items that experience normal wear and tear. ALL IMPLIED WARRANTIES ARE LIMITED IN THE DURATION TO THE WARRANTY PERIOD. AND SUCH IMPLIED WARRANTIES INCLUDING MERCHANTABILITY, FITNESS FOR A PARTICULAR PURPOSE, OR OTHERWISE, ARE DISCLAIMED IN THEIR ENTIRETY AFTER THE EXPIRATION OF THE APPROPRIATE WARRANTY PERIOD. THE DISTRIBUTOR'S OBLIGATION UNDER THE WARRANTY IS STRICTLY AND EXCLUSIVELY LIMITED TO THE REPAIR OR REPLACEMENT OF DEFECTIVE PARTS AND RETURN OF THE PRODUCT TO THE CUSTOMER. THE DISTRIBUTOR DOES NOT ASSUME OR AUTHORIZE ANYONE TO ASSUME FOR THEM ANY OTHER OBLIGATION. THE DISTRIBUTOR ASSUMES NO RESPONSIBILITY FOR INCIDENTAL, CONSEQUENTIAL OR OTHER DAMAGES INCLUDING, BUT NOT LIMITED, TO EXPENSE OF RETURNING THE PRODUCT TO THE DISTRIBUTOR, LOSS OF USE OF PRODUCT AND LOSS OF TIME OR INCONVENIENCE.

#### **EXCLUSIONS**

BATTERY. This warranty does not include the battery.

#### **CUSTOMER ENQUIRIES**

If your unit is not operating, please refer to your User Manual before contacting our Customer Service Centre. For any damage or repair work required, please do not return your product to the store where it was purchased.

#### **RETURN / REPAIR POLICY**

Customers must call our Customer Service Centre and ask for a Return / Repair Authorization Number before sending the product to the Service Centre. Returned products must be shipped with original packaging including the polystyrene packing material and all defective parts. Please contact our Customer Service Centre for assistance in handling your case.

**UNITED STATES** SEA-DOO® SEASCOOTER™ CUSTOMER SERVICE CENTRE  
Phone No.: +1-800-361-2781 Email: warranty-usa@seadooseascooter.com

**CANADA** SEA-DOO® SEASCOOTER™ CUSTOMER SERVICE CENTRE  
Phone No.: +1-888-388-8837 Email: warranty-can@seadooseascooter.com

**WESTERN EUROPE** SEA-DOO® SEASCOOTER™ CUSTOMER SERVICE CENTRE  
Phone No.: +44 (0)1709 515157 Email: john@alphad.org

**EASTERN, SOUTHERN AND CENTRAL EUROPE** SEA-DOO® SEASCOOTER™ CUSTOMER SERVICE CENTRE  
Phone No.: +386 5616 50 20 Email: service@kernsport.com

**HONG KONG** SEA-DOO® SEASCOOTER™ CUSTOMER SERVICE CENTRE  
Phone No.: +852 3516 2388 Email: service@stallionasia.com

**(For other territories, please visit [www.seadooseascooter.com](http://www.seadooseascooter.com) and contact your local distributor)**

#### **RETURN / REPAIR PROCEDURE**

1. Call the Customer Service Centre for your Return / Repair Authorization Number.
  2. Make a copy of your Proof of Purchase (receipt).
  3. Pack the defective unit in its original packaging including the polystyrene foam and include the unit and all defective parts.
  4. Attach the copy of your Proof of Purchase (receipt) to the outside of the box (clearly visible), together with the Return / Repair Authorization Number.
  5. Ship the package to the Service Centre.
- PLEASE NOTE:** Deliveries that do not have the Proof of Purchase (receipt) and Return / Repair Authorization Number attached clearly to the outside of the box, will not be accepted by the Service Centre.

**For any questions or queries you may have regarding your SEA-DOO® SEASCOOTER™, please follow the below steps for easy and fast resolution:**

#### **- STEP 1-**

Please read your User Manual. For a copy of the User Manuals, please visit [www.seadooseascooter.com](http://www.seadooseascooter.com)

#### **- STEP 2-**

Go to [www.seadooseascooter.com](http://www.seadooseascooter.com) and see our FAQ section to find instant answers.

#### **- STEP 3-**

Contact one of our Customer Service representatives at the Customer Service Centre in your region.